



**U.S. Army Medical Materiel Agency
(USAMMA)/Distribution Operations Center (DOC)**

**Packing Protocols for Temperature
Sensitive Medical Products requiring
Storage and Transportation
Temperatures between
2°C - 8°C (36°F - 46°F).**

Table of contents:

	page
Packing Protocols:	
Endurotherm (ISC) Box Packing Steps	3
Cold Weather Packing Protocol.....	4
Cold Weather Packing Protocol Procedures	5
Cold Weather Packing Protocols Diagrams.....	6
Moderate Weather Packing Protocol	10
Moderate Weather Packing Protocol Procedures	11
Moderate Weather Packing Protocol Diagrams	12
Warm Weather Packing Protocol	16
Warm Weather Packing Protocol Procedures.....	17
Warm Weather Packing Protocol Diagrams	18
TempTale Procedures:	
TempTale 4:	
Starting a TempTale 4	22
Reading a TempTale 4	23
Helpful Websites.....	24

Endurotherm (ISC) Box Packing Steps

The packing or layering of the Endurotherm boxes is the same in principle for all four sizes (Extra large, large, medium and small).

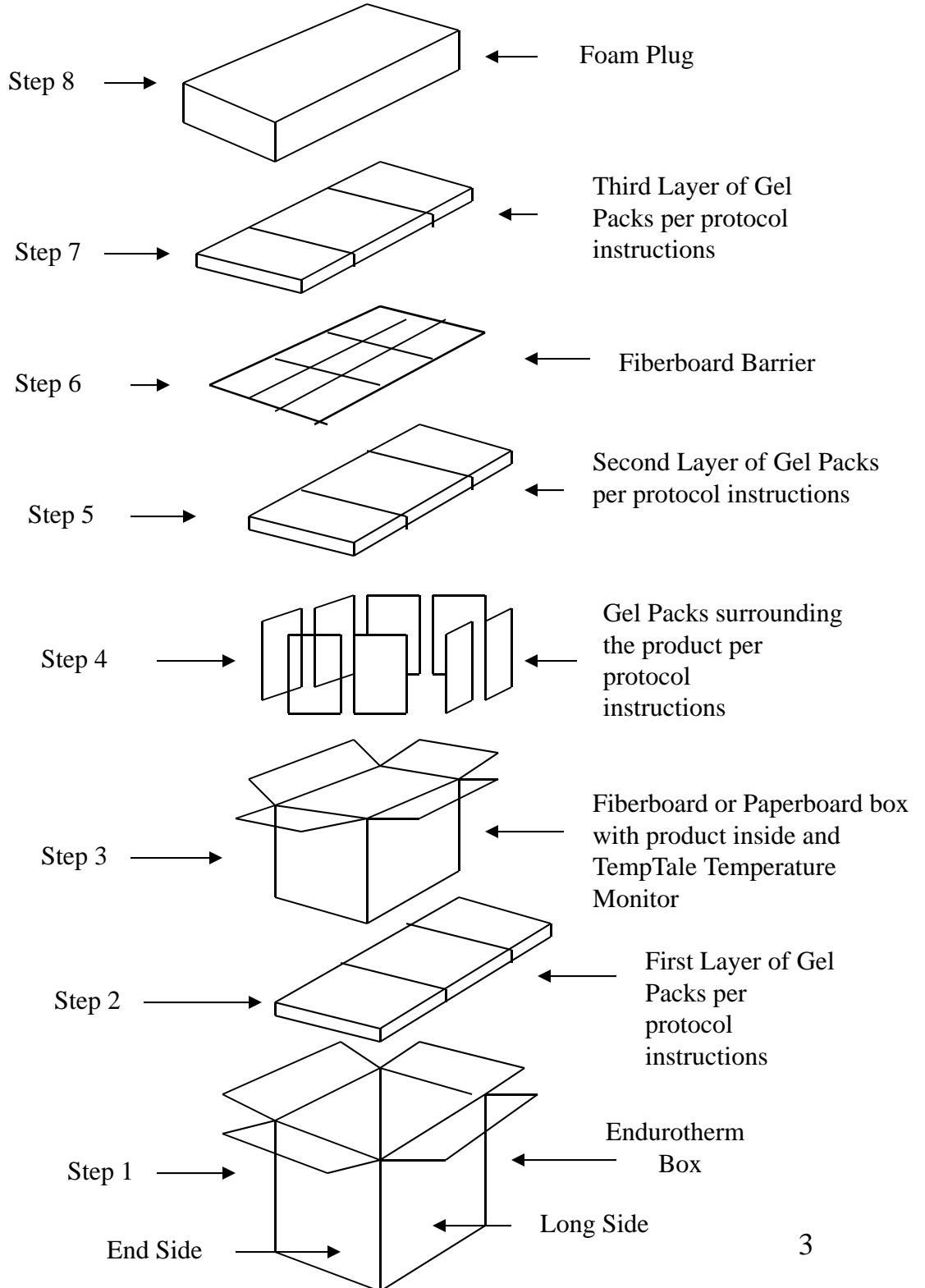

Cold Weather Packing Protocol

- Cold Weather Configuration is used when the ambient temperature at the **receiving site** is consistently below 55°F or 13°C.
- Protocols are designed to keep temperature sensitive products requiring refrigeration temperatures between 36°F to 46°F or 2° C to 8° C within these temperature ranges during transportation, for up to 72 hours.
- 48 oz. and 24 oz. gel packs are used in all boxes for layering and void space filler.
- Coolant material must be placed in layers according to attached diagrams. Cold Weather configurations only use refrigerated gel packs. (See cold weather packing configuration diagrams.)

Cold Weather Packing Protocol Procedures

The Cold Weather Packing Protocol is used whenever the ambient or outside temperature at the receiving site consistently remains below 55°F or 13°C. Begin the Cold Weather packing protocol by:

- o Placing a layer of refrigerated gel packs at the bottom of the box.
- o Next item will be the product.
- o Place refrigerated gel packs around the product's side(s) to fill in gap between product and the insulated walls of the box.
- o This is followed by placing an activated TempTale electronic temperature monitor on top of the product, activate the TempTale temperature monitor by pressing and releasing the "start" button. Once the button is released, a "sunshine" icon will appear in the upper left corner of the LCD. This indicates that the monitor is running. Peel off the tape in the back of the TempTale and place it centered on top of the product.
- o Follow with another layer of refrigerated gel packs.
- o Above the second layer of refrigerated gel packs insert a fiberboard barrier.
- o Add a final layer of refrigerated gel packs above the fiberboard barrier.
- o Finally, insert the foam plug to seal the contents of the box.

Notes:

- o Follow procedures according to each protocol diagram of ISC box used.
- o To chill large amounts of gel packs at once, place gel pack boxes inside a refrigerator that has been set to 4° C for at least 30 days prior to use.
- o To quickly chill small amounts of gel packs, place them in a single layer inside a refrigerator as explained above for at least 24 hours prior use.

Extra Large (ISC Box, E-327) – Cold Weather Packing Protocol Diagrams (880 vials of Anthrax Vaccine)

Total amount of chilled Gel Packs = 27

Approximate Weight:

Max load = 145 lbs

Min load = 120 lbs

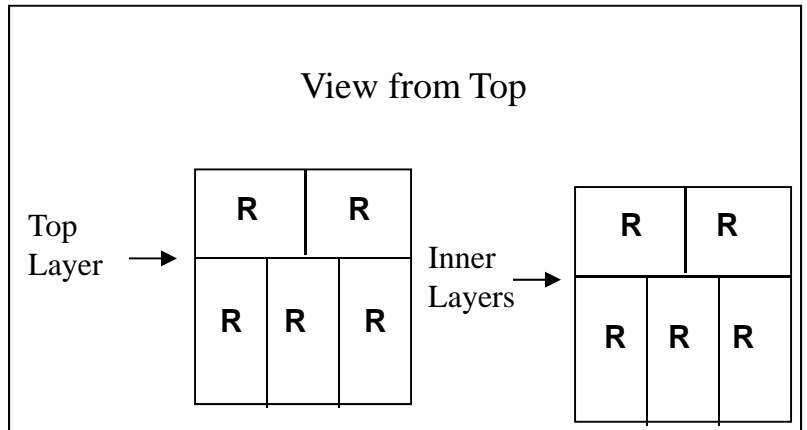

Layer 3:

5 Large Refrigerated Gel Packs (48 oz. each)

Fiberboard Barrier

Layer 2:

5 Large Refrigerated Gel Packs (48 oz. each)

Use a total of 12 Large Refrigerated Gel Packs (6 on each long side 48 oz. Each)

Layer 1: 5 Large Refrigerated Gel Packs (48 oz. each)

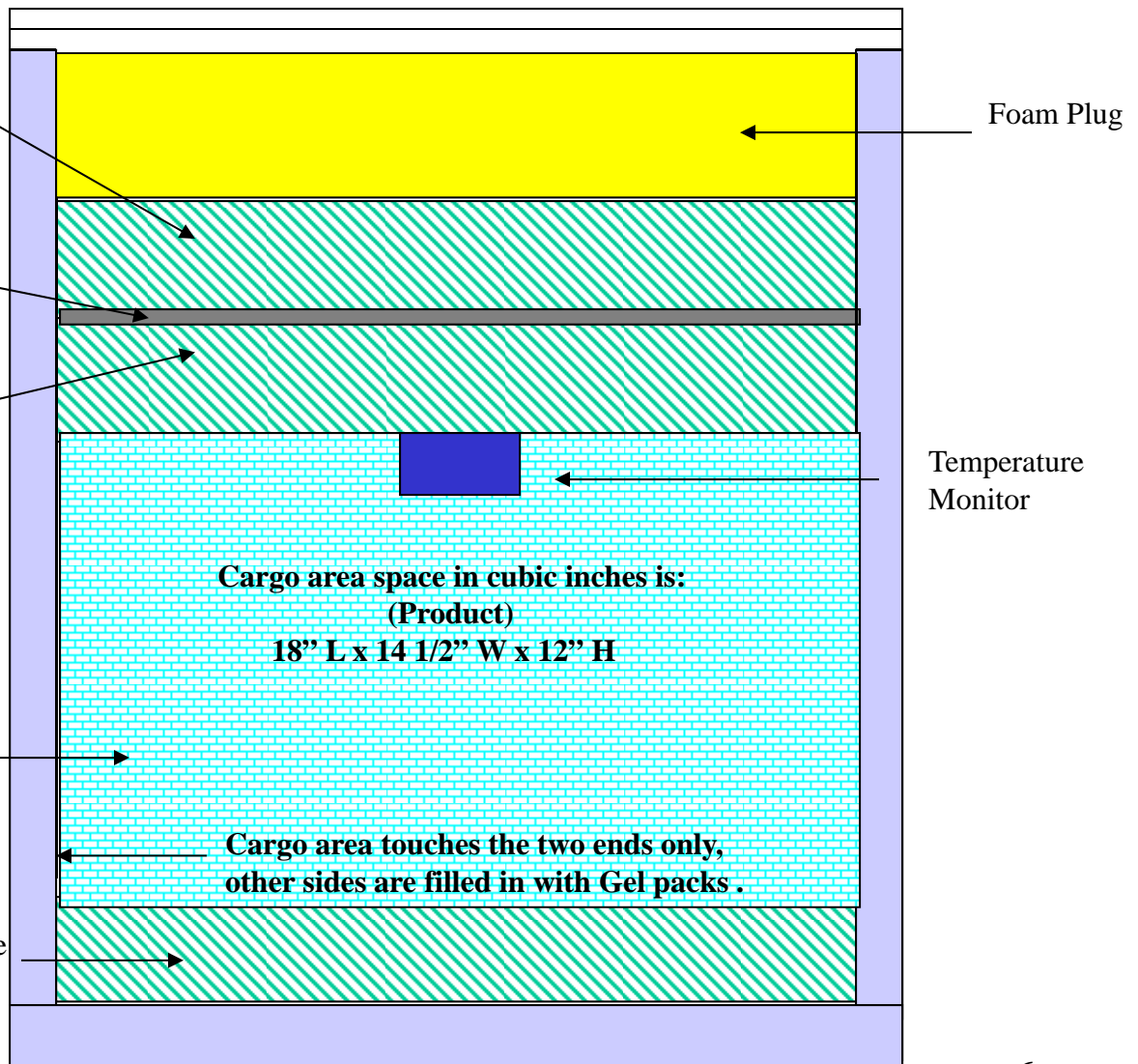

Side View

Large (ISC Box, E-186) – Cold Weather Packing Protocol Diagrams (440 vials Anthrax Vaccine)

Total amount of chilled Gel Packs = 17
Approximate Weight:
 Max load = 75 lbs
 Min load = 50 lbs

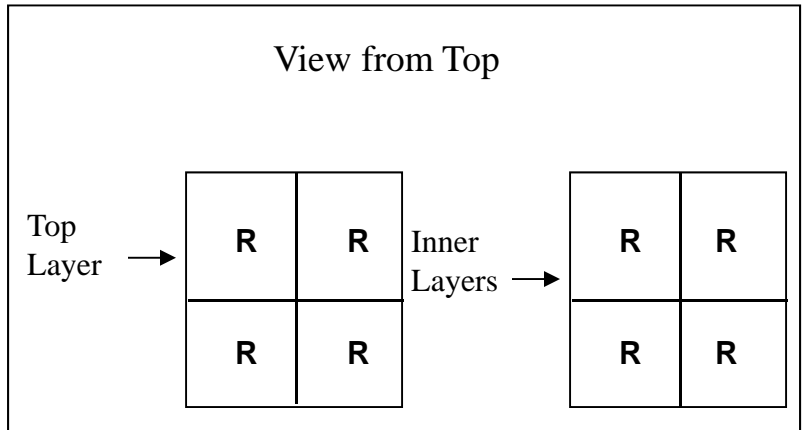

Layer 3:

4 Large Refrigerated Gel Packs (48 oz. each)

Fiberboard Barrier

Layer 2: 4 Large Refrigerated Gel Packs (48 oz. each)

Layer 1: 4 Large Refrigerated Gel Packs (48 oz. each)

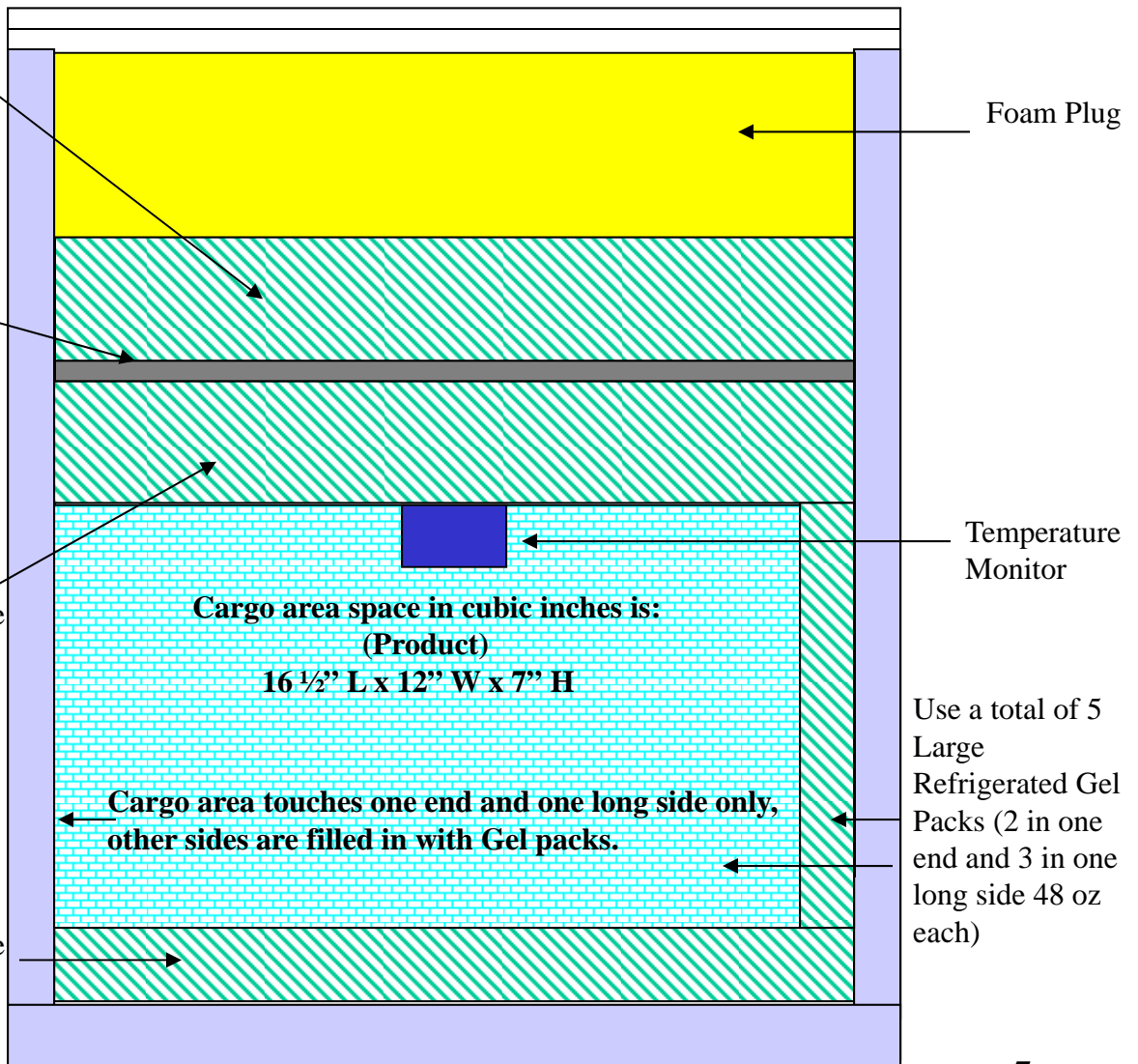

Side View

Medium (ISC Box, E-65) – Cold Weather Packing Protocol Diagrams (53 – 110 vials of Anthrax Vaccine)

Total amount of chilled Gel Packs = 13
Approximate Weight:
 Max load = 40 lbs
 Min load = 30 lbs

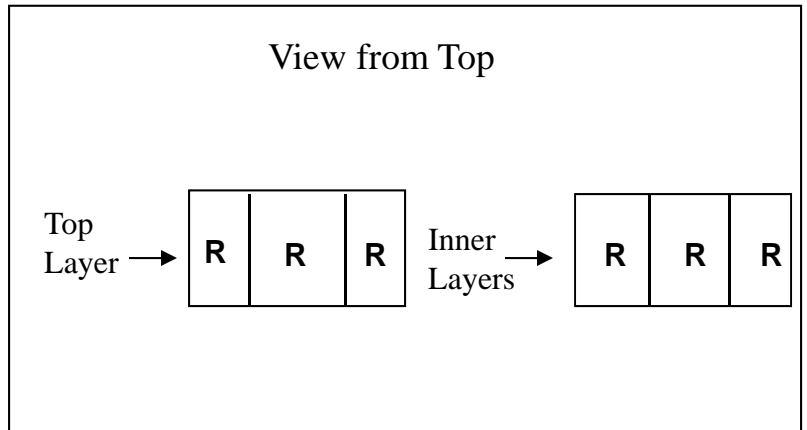

Layer 3:

3 Medium Refrigerated Gel Packs (24 oz. each)

Fiberboard Barrier

Layer 2:

3 Medium Refrigerated Gel Packs (24 oz. each)

Layer 1:

3 Medium Refrigerated Gel Packs (24 oz. each)

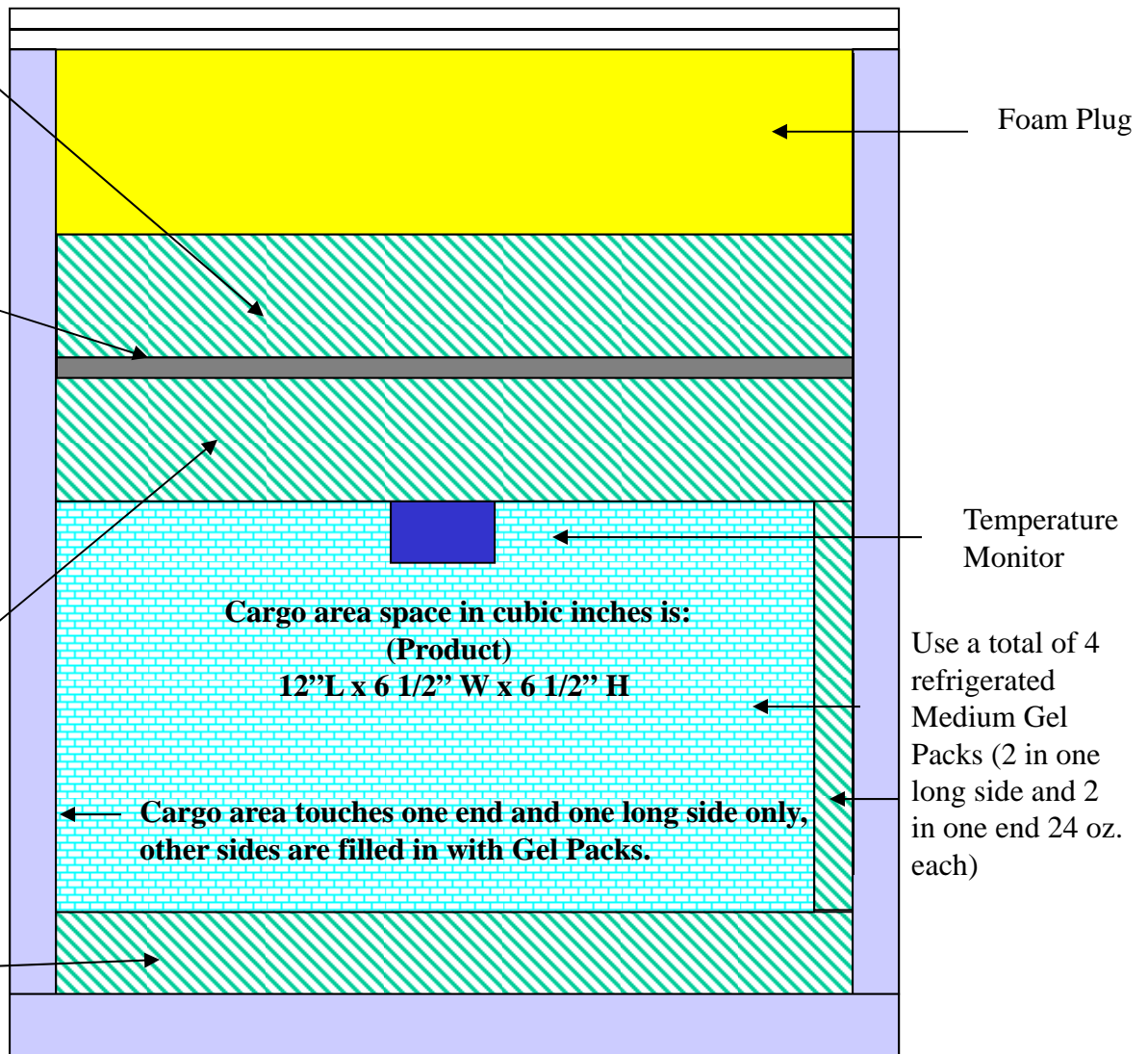

Side View

Small (ISC Box E-36-2) – Cold Weather Packing Protocol Diagrams (1 – 25 vials of Anthrax Vaccine)

Total amount of chilled Gel Packs = 8
Approximate Weight:
 Max load = 20 lbs
 Min load = 15 lbs

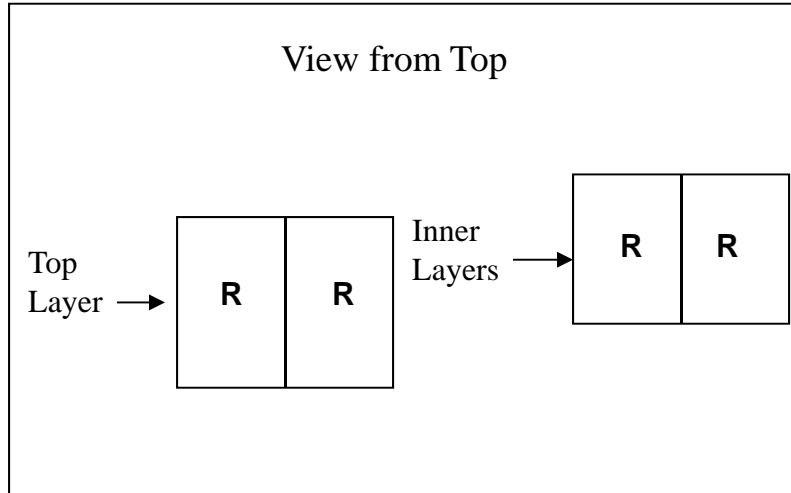

Layer 3:

2 Medium Refrigerated Gel Packs (24 oz. each)

Fiberboard Barrier

Layer 2:

2 Medium Refrigerated Gel Packs (24 oz. each)

Layer 1:

2 Medium Refrigerated Gel Packs (24 oz. each)

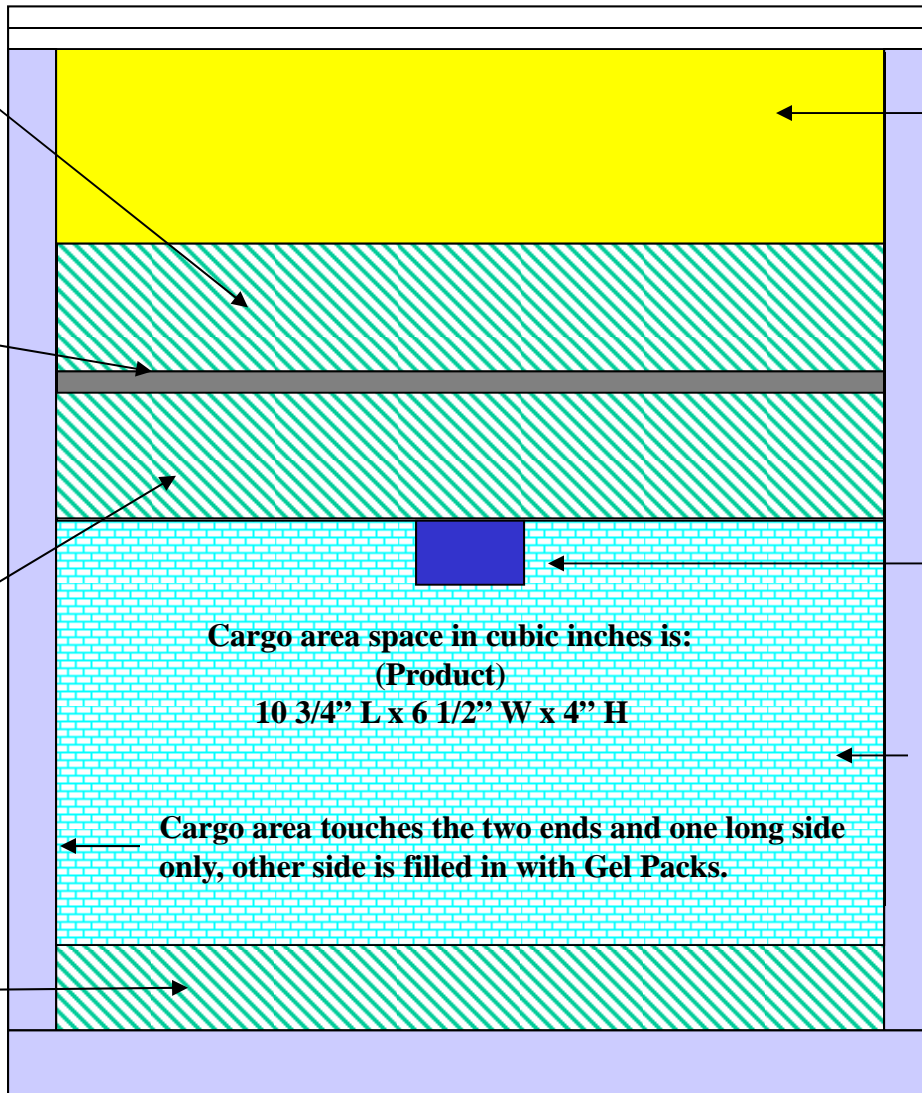

Foam Plug

Temperature Monitor

2 Medium Refrigerated Gel Packs in one long side only (24 oz each).

**Cargo area space in cubic inches is:
(Product)
10 3/4" L x 6 1/2" W x 4" H**

Cargo area touches the two ends and one long side only, other side is filled in with Gel Packs.

Side View

Moderate Weather Packing Protocol

- Moderate Weather Configuration is used when the ambient temperature **at the receiving site** is between 55° F to 77° F or 14°C to 25°C.
- Protocols are designed to keep temperature sensitive products requiring refrigeration temperatures between 36°F to 46°F or 2°C to 8°C within these temperature ranges during transportation, for up to 72 hours.
- 48 oz. and 24 oz. gel packs are used in all boxes for layering and fill in.
- Coolant material must be placed in layers according to attached diagrams. **Frozen gel packs are always farthest away from vaccine.**

Moderate Weather Packing Protocol Procedures

The Moderate Weather Packing Protocol is used whenever the ambient or outside temperature at the receiving site is between 55°F and 77°F or 14°C to 25°C. Begin the Moderate Weather packing protocol by:

- o Placing a layer of refrigerated gel packs at the bottom of the box.
- o Next item will be the product.
- o Place refrigerated gel packs around the product's side(s) to fill in gap between product and the insulated walls of the box.
- o This is followed by placing an activated TempTale electronic temperature monitor on top of the product, activate the TempTale temperature monitor by pressing and releasing the "start" button. Once the button is released, a "sunshine" icon will appear in the upper left corner of the LCD. This indicates that the monitor is running. Peel off the tape in the back of the TempTale and place it centered on top of the product.
- o Follow with another layer of refrigerated gel packs.
- o Above the second layer of refrigerated gel packs insert a fiberboard barrier.
- o Add a final layer of a combination of refrigerated and frozen gel packs above the fiberboard barrier.
- o Finally, insert the foam plug to seal the contents of the box.

Notes:

- o Follow procedures according to each protocol diagram of ISC box used.
- o To chill large amounts of gel packs at once, place gel pack boxes inside a refrigerator that has been set to 4° C for at least 30 days prior to use.
- o To quickly chill small amounts of gel packs, place them in a single layer inside a refrigerator as explained above for at least 24 hours prior use.
- o To freeze large amounts of gel packs at once, place gel pack boxes inside a freezer that has been set to -20°C for at least 30 days prior use.
- o To quickly freeze small amounts of gel packs, place them in a single layer inside a freezer as explained above for at least 24 hours prior to use (lay them flat to ensure they maintain their original shape once they are frozen) .

Extra Large (ISC Box, E-327) – Moderate Weather Packing Protocols Diagrams (880 vials of Anthrax Vaccine)

Total amount of Gel Packs:

Chilled = 26

Frozen = 1

Approximate Weight:

Max load = 145 lbs

Min load = 120 lbs

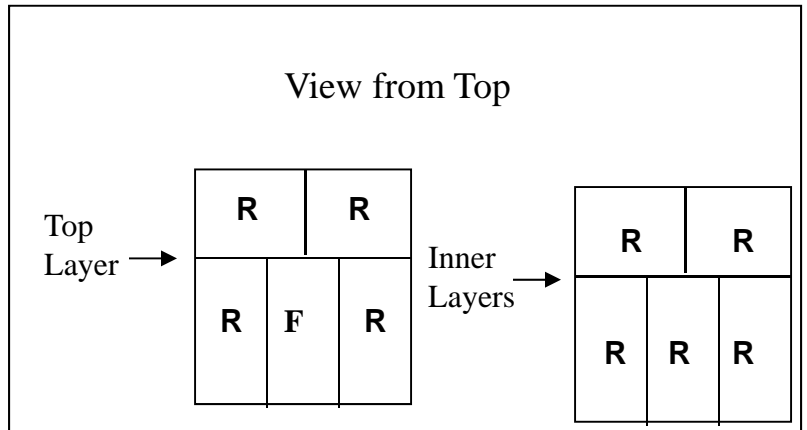

Layer 3: 1

Large Frozen & 4 Large Refrigerated Gel Packs (48 oz. each)

Fiberboard Barrier

Layer 2: 5 Large Refrigerated Gel Packs (48 oz. each)

Use a total of 12 Large Refrigerated Gel Packs (6 on each long side 48 oz. Each)

Layer 1: 5 Large Refrigerated Gel Packs (48 oz. each)

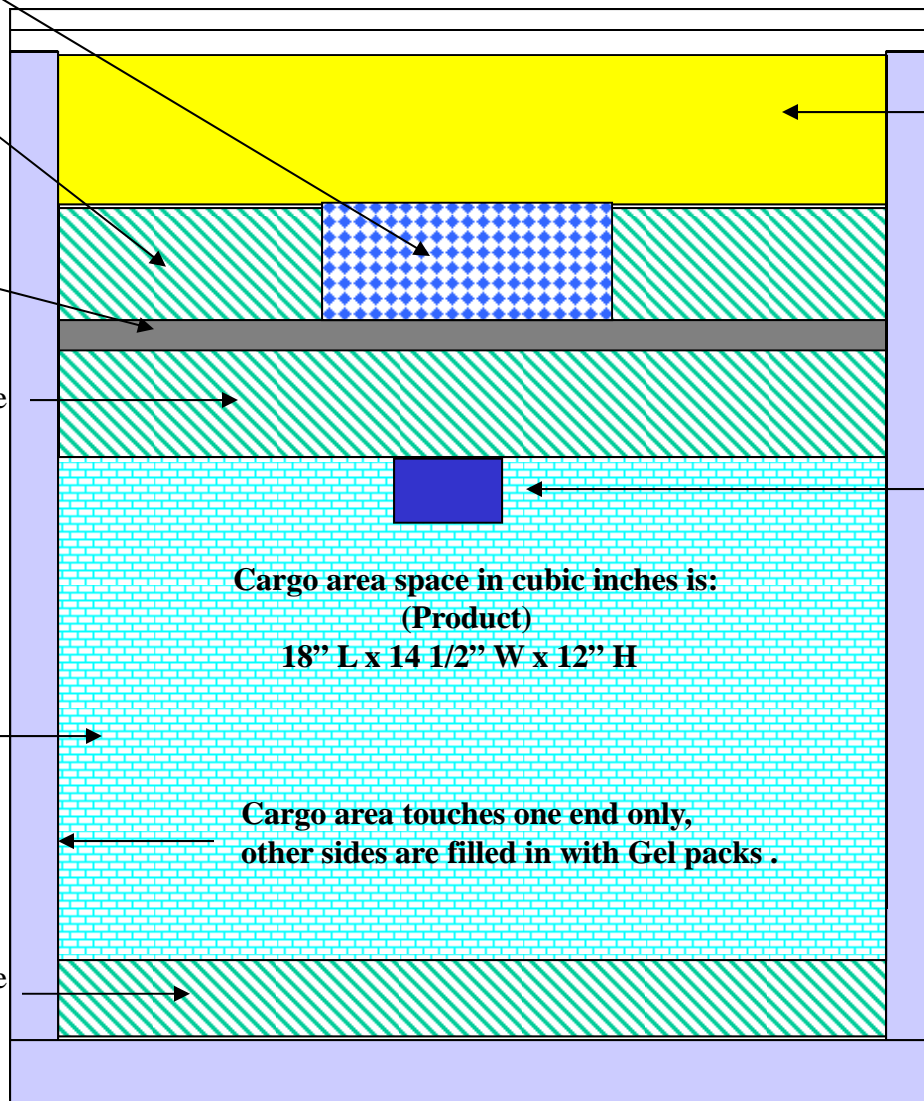

Foam Plug

Temperature Monitor

**Cargo area space in cubic inches is:
(Product)
18" L x 14 1/2" W x 12" H**

**Cargo area touches one end only,
other sides are filled in with Gel packs .**

Side View

Large (ISC Box, E-186) – Moderate Weather Packing Protocols Diagrams (440 vials Anthrax Vaccine)

Total amount of Gel Packs:

Chilled = 16

Frozen = 1

Approximate Weight:

Max load = 75 lbs

Min load = 50 lbs

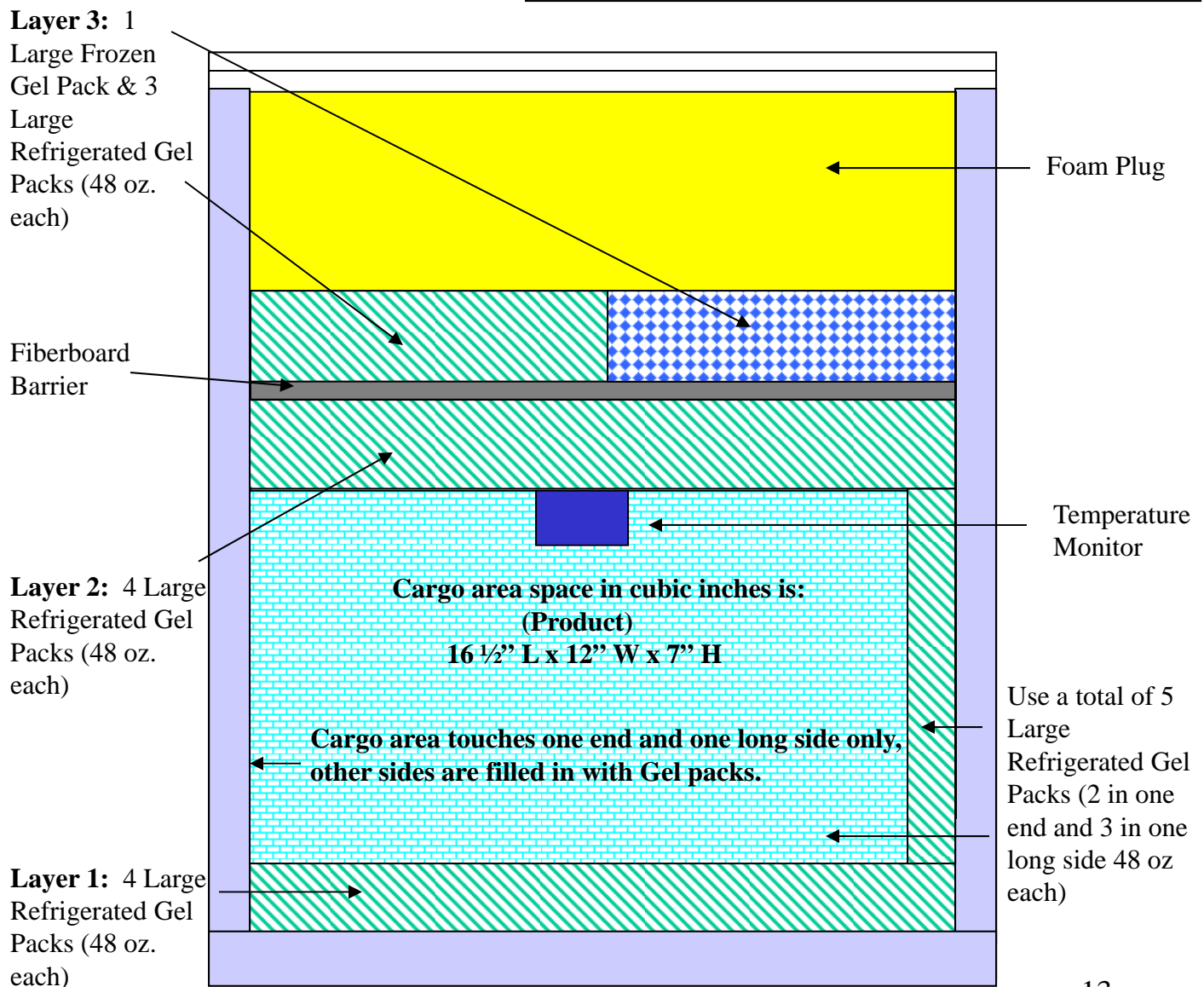
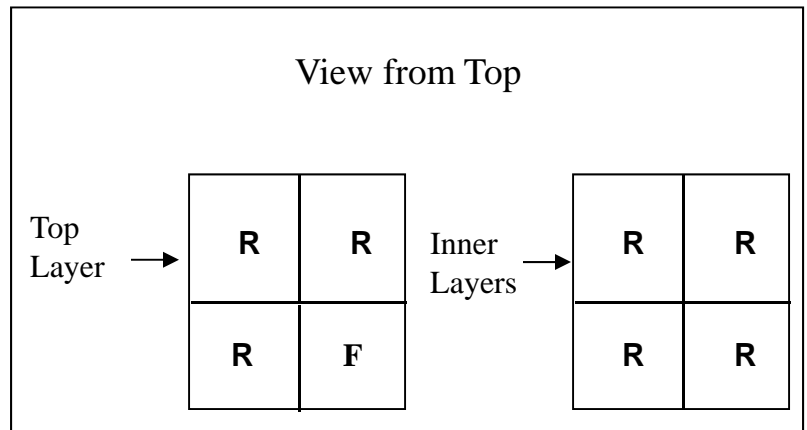

Side View

Medium (ISC Box, E-65) – Moderate Weather Packing Protocols Diagrams (53 – 110 vials of Anthrax Vaccine)

Total amount of Gel Packs = 13
 Chilled = 12
 Frozen = 1
Approximate Weight:
 Max load = 40 lbs
 Min load = 30 lbs

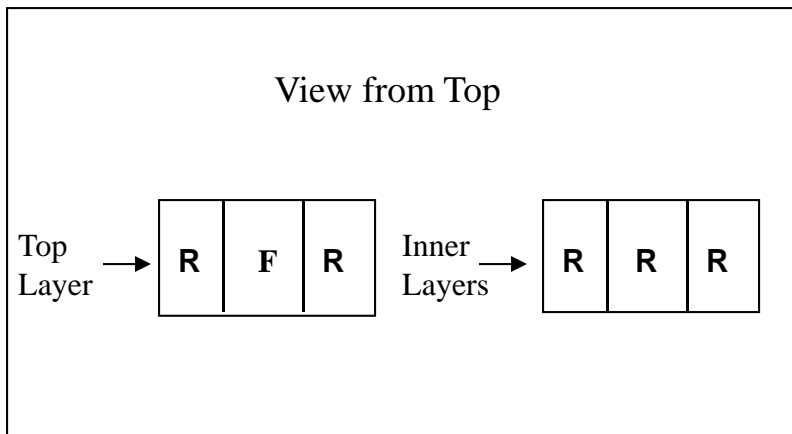

Layer 3:

1 Medium Frozen Gel Pack & 2 Medium Refrigerated Gel Packs (24 oz. each)

Fiberboard Barrier

Layer 2:

3 Medium Refrigerated Gel Packs (24 oz. each)

Layer 1: 3 Medium Refrigerated Gel Packs (24 oz. each)

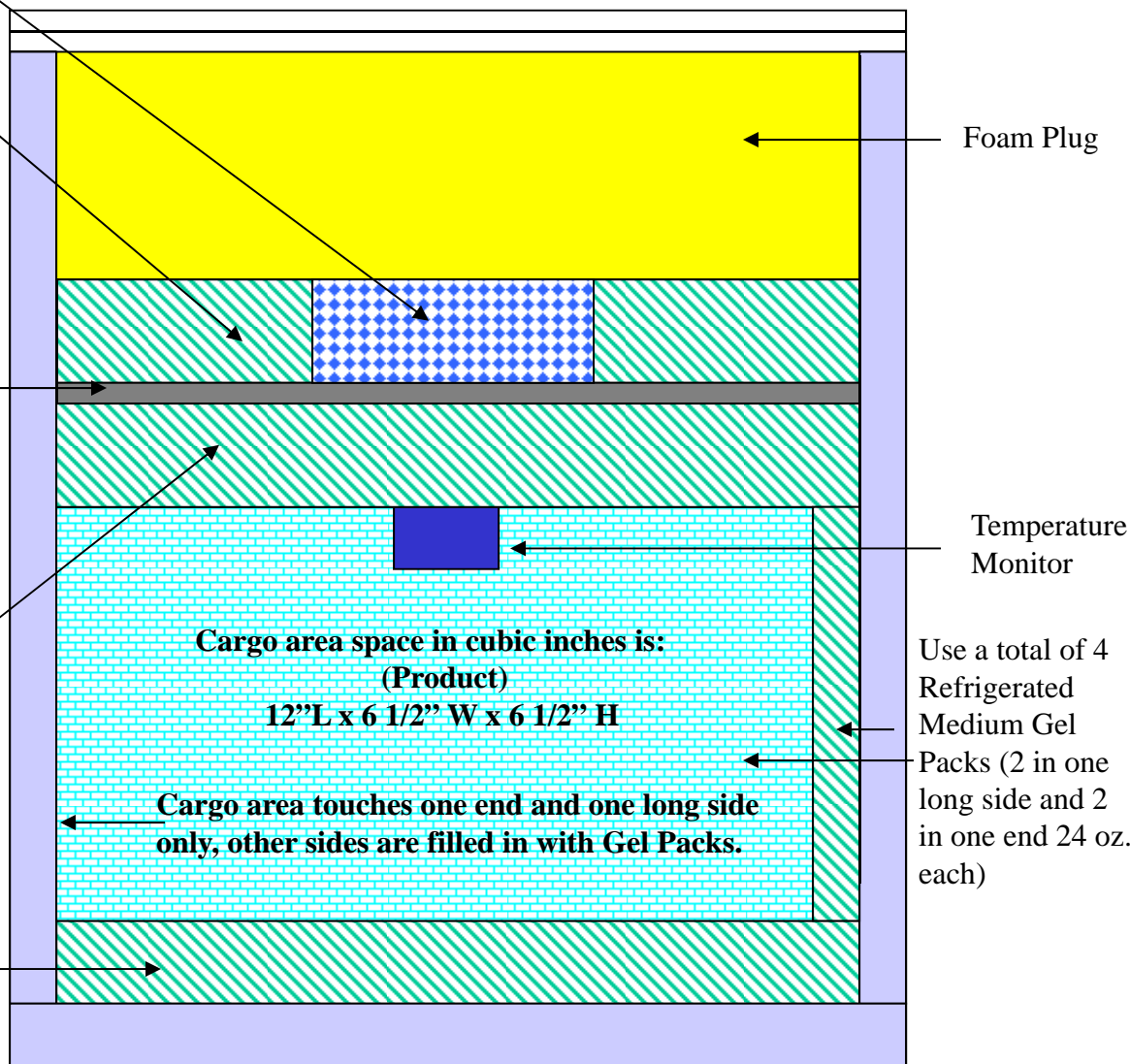

Side View

Small (ISC Box E-36-2) – Moderate Weather Packing Protocols Diagrams

(1 – 25 vials of Anthrax Vaccine)

Total amount of Gel Packs = 8
 Chilled = 7
 Frozen = 1
Approximate Weight:
 Max load = 20 lbs
 Min load = 15 lbs

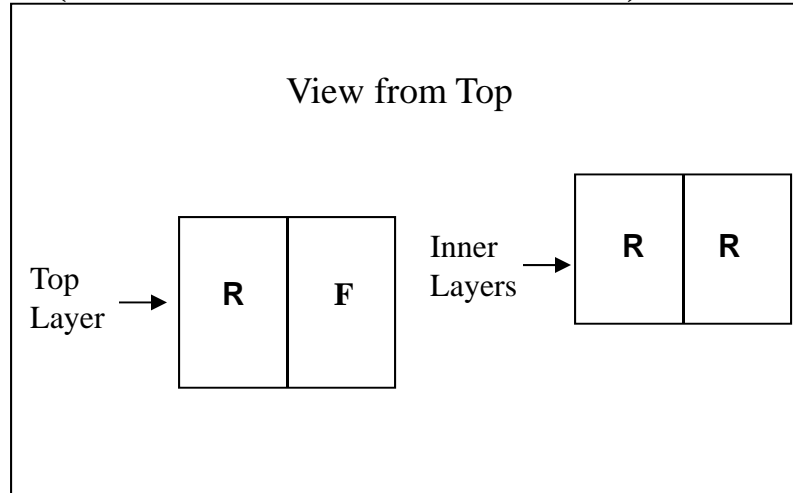

Layer 3:

1 Medium Frozen Gel Pack & 1 Medium Refrigerated Gel Pack (24 oz. each)

Foam Plug

Fiberboard Barrier

Layer 2:

2 Medium Refrigerated Gel Packs (24 oz. each)

Temperature Monitor

**Cargo area space in cubic inches is:
 (Product)
 10 3/4" L x 6 1/2" W x 4" H**

2 Medium Refrigerated Gel Packs in one long side only (24 oz each).

Cargo area touches the two ends and one long side only, other side is filled in with Gel Packs.

Layer 1:

2 Medium Refrigerated Gel Packs (24 oz. each)

Side View

Warm Weather Packing Protocol

- Warm Weather Configuration is used when the ambient temperature **at the receiving site** is consistently above 77°F or 25°C.
- Protocols are designed to keep temperature sensitive products requiring refrigeration temperatures between 36°F to 46°F or 2° C to 8° C within these temperature ranges during transportation, for up to 72 hours.
- 48 oz. and 24 oz. gel packs are used in all boxes for layering and fill in.
- Coolant material must be placed in layers according to diagrams. **Frozen packs are always farthest away from vaccine.**

Warm Weather Packing Protocol Procedures

The Warm Weather Packing Protocol is used whenever the ambient or outside temperature at the receiving site is consistently above 77° F or 25°C. Begin the Warm Weather packing protocol by:

- o Placing a layer of refrigerated gel packs at the bottom of the box.
- o Next item will be the product.
- o Place refrigerated gel packs around the product's side(s) to fill in gap between product and the insulated walls of the box.
- o This is followed by placing an activated TempTale electronic temperature monitor on top of the product, activate the TempTale temperature monitor by pressing and releasing the "start" button. Once the button is released, a "sunshine" icon will appear in the upper left corner of the LCD. This indicates that the monitor is running. Peel off the tape in the back of the TempTale and place it centered on top of the product.
- o Follow with another layer(s) of refrigerated gel packs.
- o Above the second layer of refrigerated gel packs insert a fiberboard barrier.
- o Add a final layer of a combination of refrigerated and frozen gel packs above the fiberboard barrier.
- o Finally, insert the foam plug to seal the contents of the box.

Notes:

- o Follow procedures according to each protocol diagram of ISC box used.
- o To chill large amounts of gel packs at once, place gel pack boxes inside a refrigerator that has been set to 4° C for at least 30 days prior to use.
- o To quickly chill small amounts of gel packs, place them in a single layer inside a refrigerator as explained above for at least 24 hours prior use.
- o To freeze large amounts of gel packs at once, place gel pack boxes inside a freezer that has been set to -20°C for at least 30 days prior use.
- o To quickly freeze small amounts of gel packs, place them in a single layer inside a freezer as explained above for at least 24 hours prior to use (lay them flat to ensure they maintain their original shape once they are frozen) .

Extra Large (ISC Box, E-327) – Warm Weather Packing Protocol Diagrams (880 vials of Anthrax Vaccine)

Total amount of Gel Packs = 27

Chilled = 25

Frozen = 2

Approximate Weight:

Max load = 145 lbs

Min load = 120 lbs

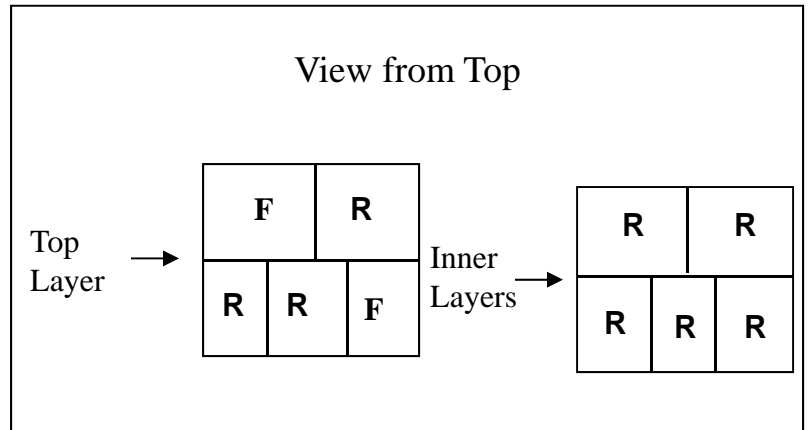

Layer 3:

2 Large Frozen & 3 Large Refrigerated Gel Packs (48 oz. each)

Fiberboard Barrier

Layer 2: 5 Large Refrigerated Gel Packs (48 oz. each)

Use a total of 12 Large Refrigerated Gel Packs (6 on each long side 48 oz. Each)

Layer 1: 5 Large Refrigerated Gel Packs (48 oz. each)

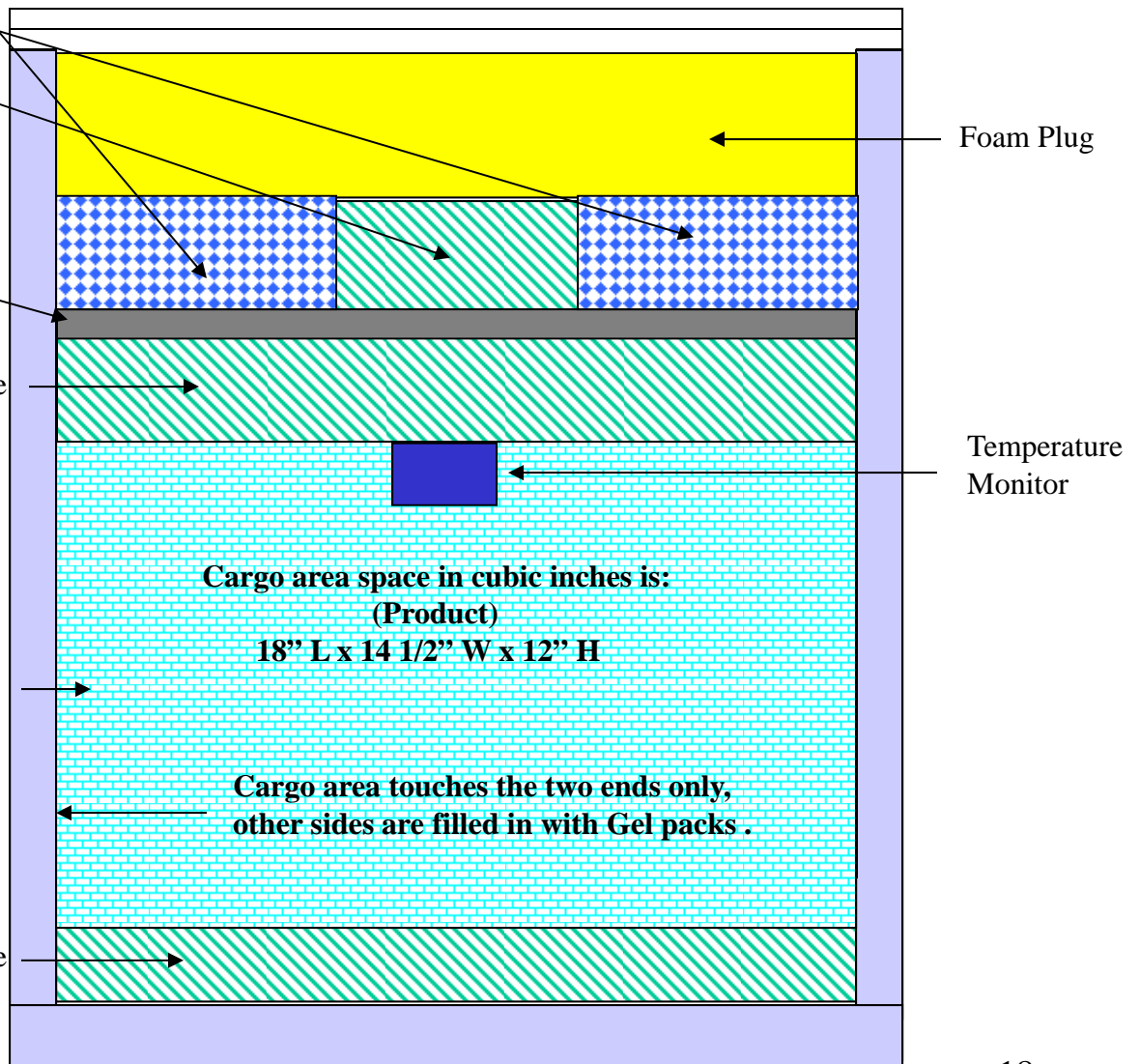

Side View

Large (ISC Box, E-186) – Warm Weather Packing Protocol Diagrams (440 vials Anthrax Vaccine)

Total amount of Gel Packs:

Chilled = 15

Frozen = 2

Approximate Weight:

Max load = 75 lbs

Min load = 50 lbs

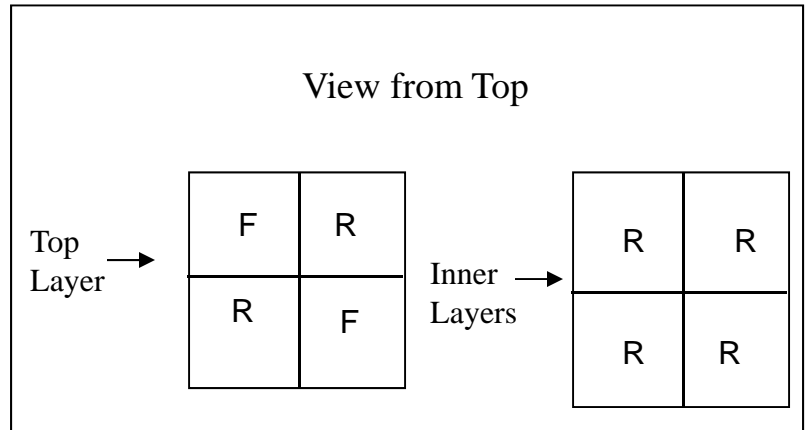

Layer 3:

2 Large Frozen Gel Packs & 2 Large Refrigerated Gel Packs (48 oz. each)

Fiberboard Barrier

Layer 2: 4 Large Refrigerated Gel Packs (48 oz. each)

Layer 1: 4 Large Refrigerated Gel Packs (48 oz. each)

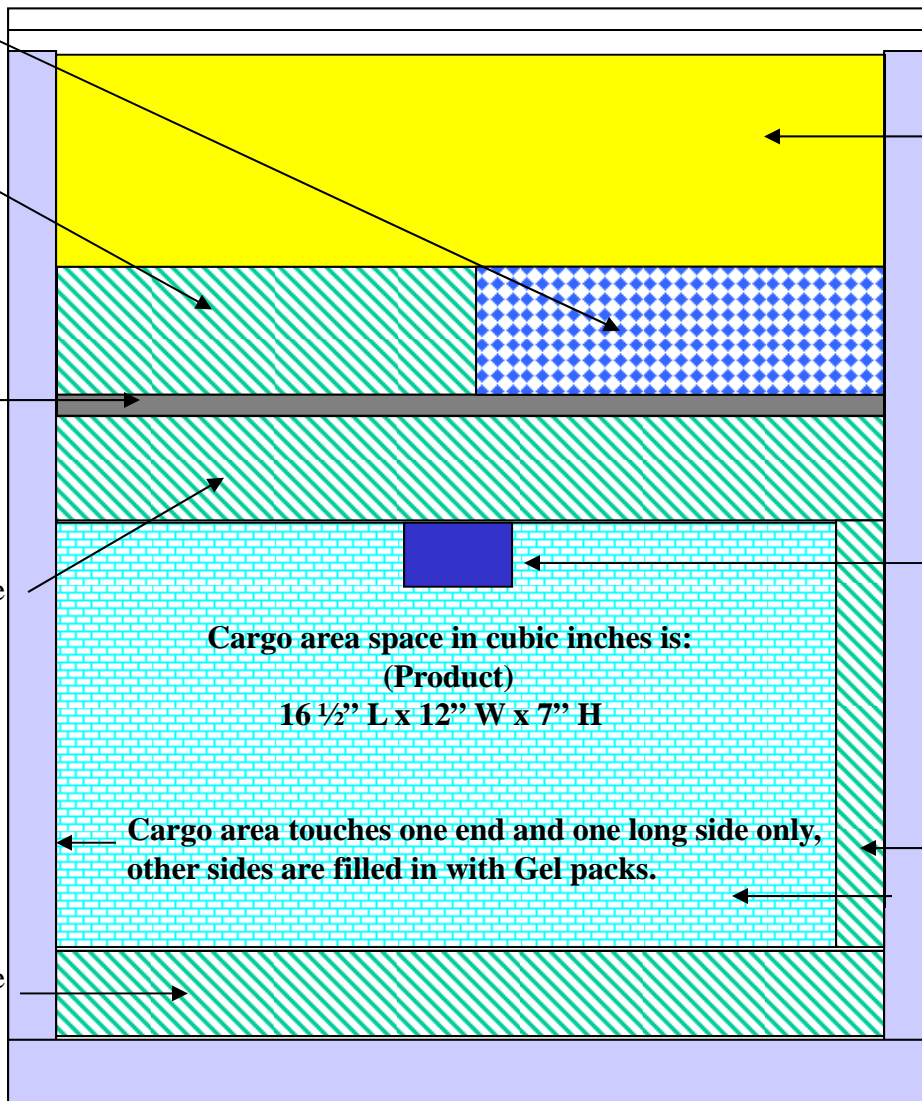

Use a total of 5 Large Refrigerated Gel Packs (2 in one end and 3 in one long side 48 oz each)

Side View

Medium (ISC Box, E-65) – Warm Weather Packing Protocol Diagrams (53 – 110 vials of Anthrax Vaccine)

Total amount of Gel Packs = 13
 Chilled = 11
 Frozen = 2
Approximate Weight:
 Max load = 40 lbs
 Min load = 30 lbs

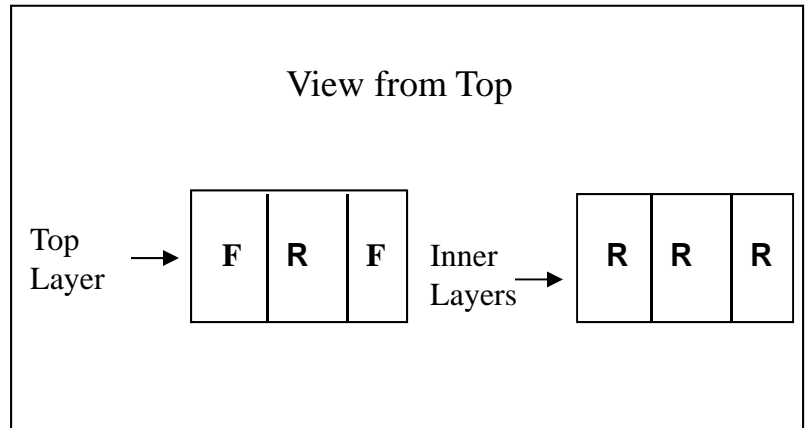

Layer 3: 2
 Medium Frozen
 Gel Packs &

1 Medium
 Refrigerated Gel
 Pack (24 oz.
 each)

Fiberboard
 Barrier

Layer 2:
 3 Medium
 Refrigerated Gel
 Packs (24 oz.
 each)

Layer 1:
 3 Medium
 Refrigerated Gel
 Packs (24 oz.
 each)

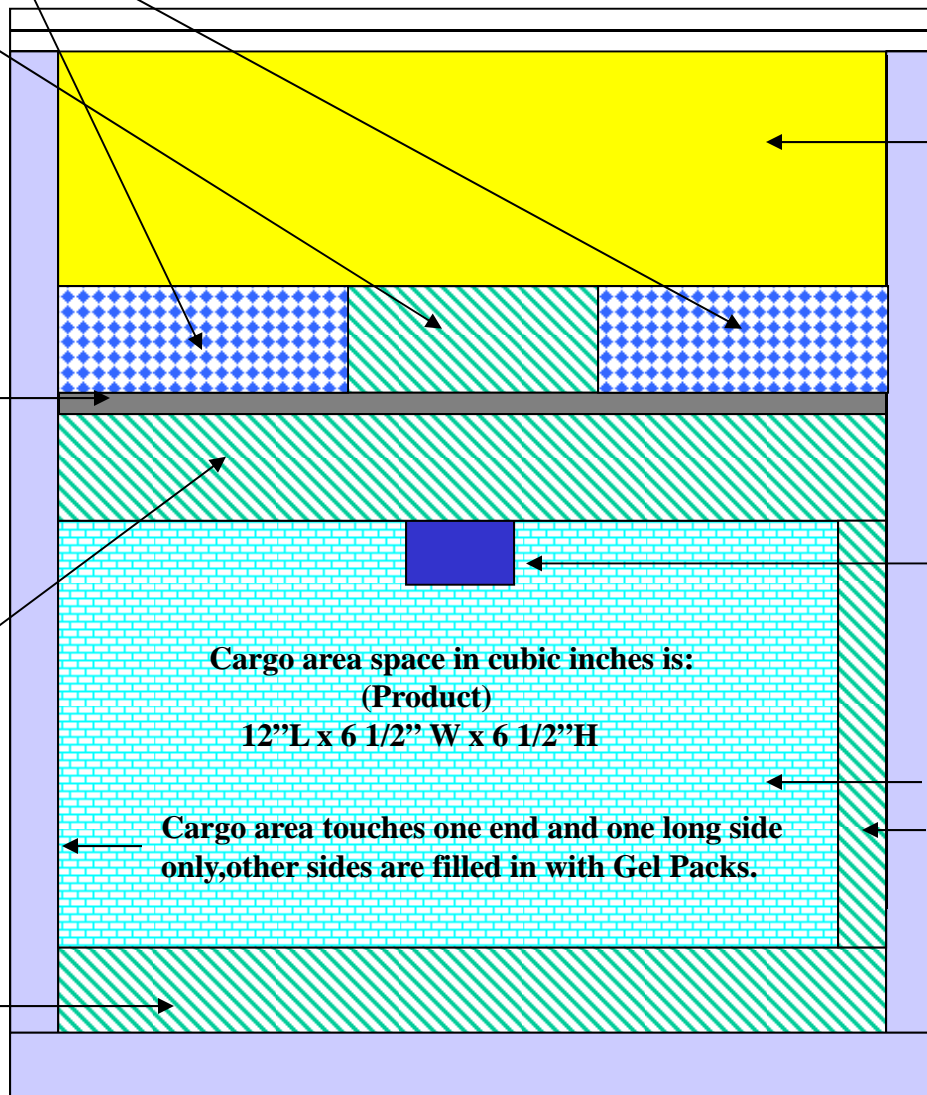

Foam Plug

Temperature Monitor

Use a total of 4 Refrigerated Medium Gel Packs (2 in one long side and 2 in one end 24 oz. each)

Side View

Small (ISC Box E-36-2) – Warm Weather Packing Protocol Diagrams

(1 – 25 vials of Anthrax Vaccine)

Total amount of Gel Packs = 8
 Chilled = 6
 Frozen = 2
Approximate Weight:
 Max load = 20 lbs
 Min load = 15 lbs

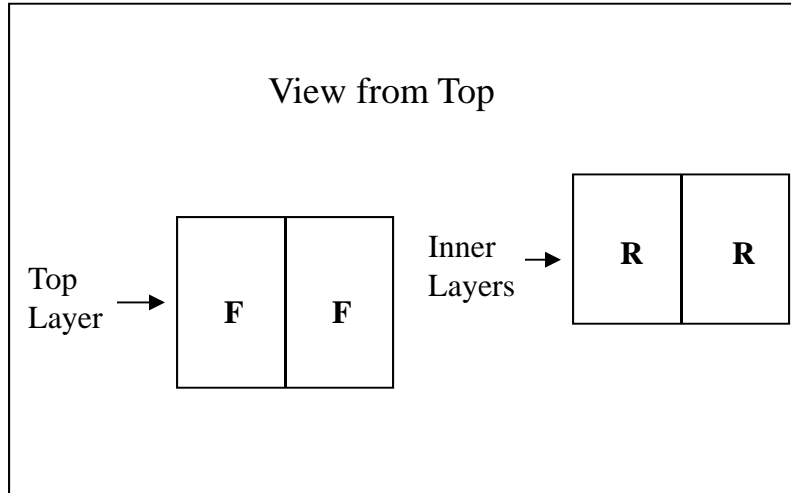

Layer 3:

2 Medium Frozen Gel Packs (24 oz. each)

Fiberboard
Cardboard
Barrier

Layer 2:

2 Medium Refrigerated Gel Packs (24 oz. each)

Layer 1:

2 Medium Refrigerated Gel Packs (24 oz. each)

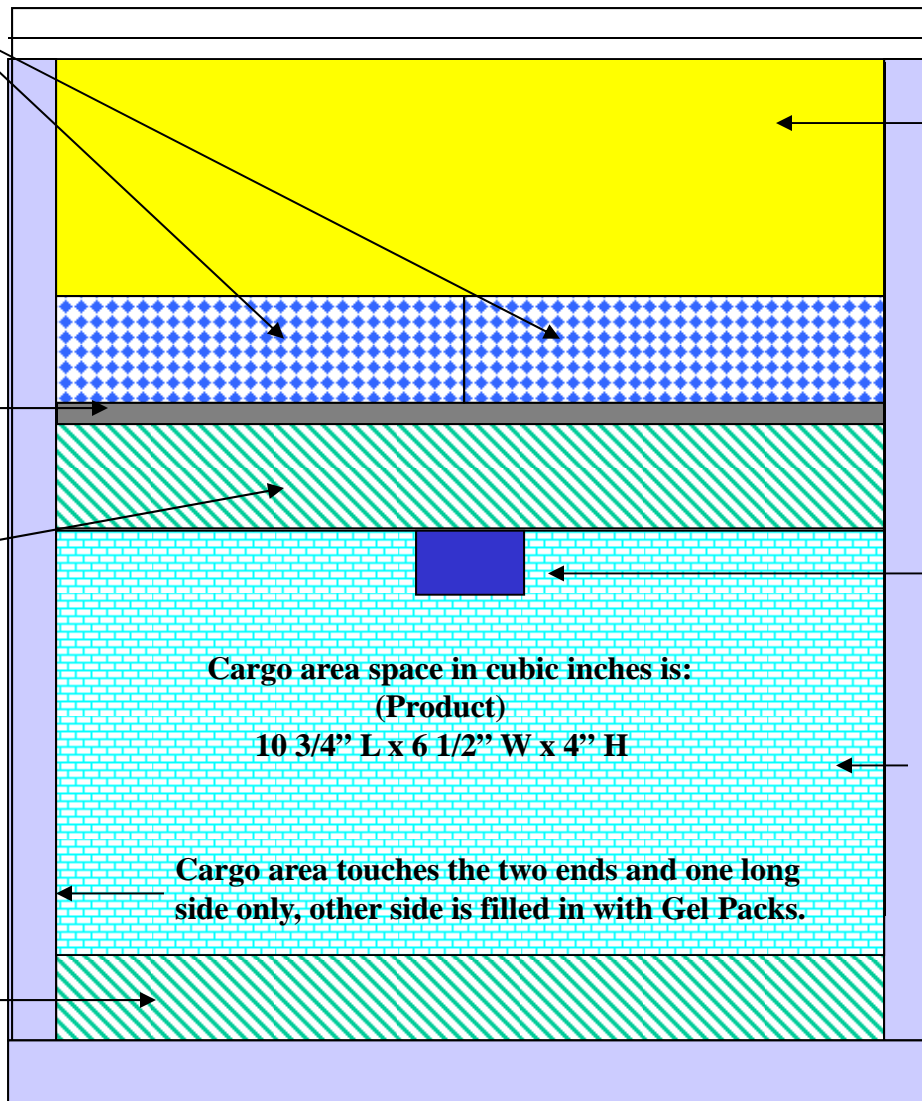

Side View

Starting a TempTale 4 Monitor

Hold down the start button (**the green button on the monitor**) until you see the sunshine icon (picture) on the upper left corner of the LCD that confirms that the monitor has started. When the monitor is activated, the sunshine icon will stay on until the monitor has been stopped. The monitor will begin recording data after the startup delay is completed.

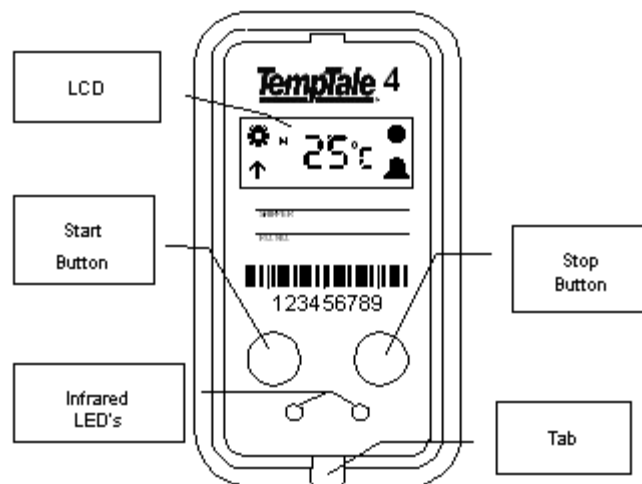

TempTale 4 Monitor

Instructions for Reading a TempTale 4 LCD

Press the **start** button. Five pieces of information will scroll, always in this order:

- Average temperature during the entire recording cycle
- Highest Temperature reached during the recording cycle
- Cumulative amount of time above the high temperature alarm
- Lowest Temperature reached during the recording cycle
- Cumulative amount of time below the low temperature alarm

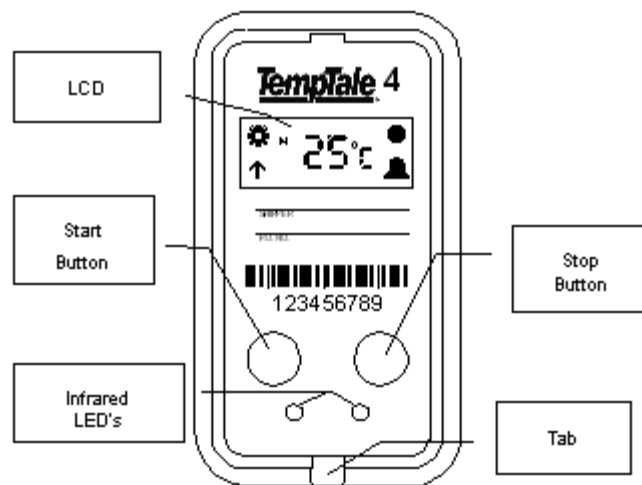

TempTale 4 Monitor

Helpful Websites

- For Fahrenheit to Celsius:
<http://www.wbuf.noaa.gov/tempfc.htm>
- For weather conditions at receiving sites:
<http://www.weather.com>
<http://www.nws.noaa.gov>